

Pattern 1:

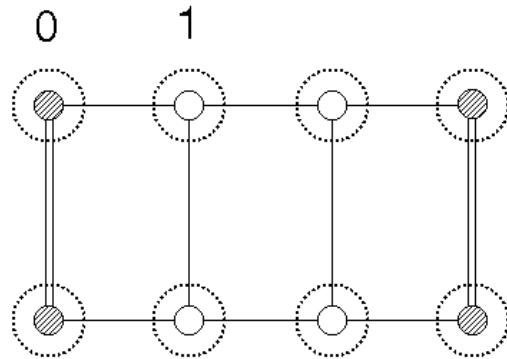

$\xrightarrow{\text{div trans}}$

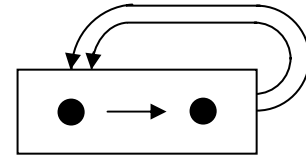
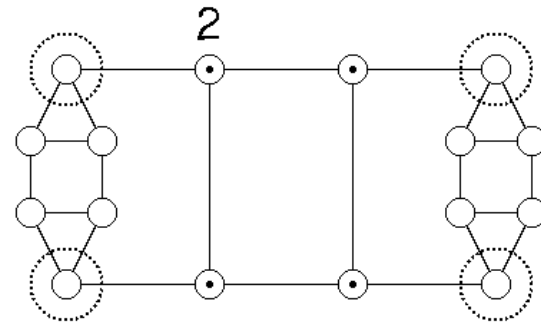

$\xrightarrow{\text{div}}$

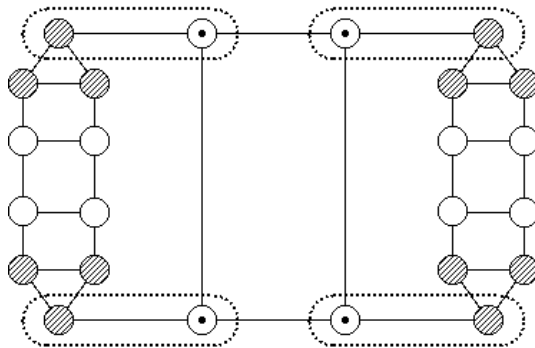

$\xrightarrow{\text{anh}}$

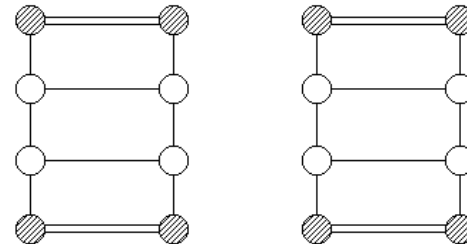

(3 states, 4 rules)

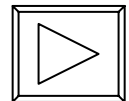

Pattern 2:

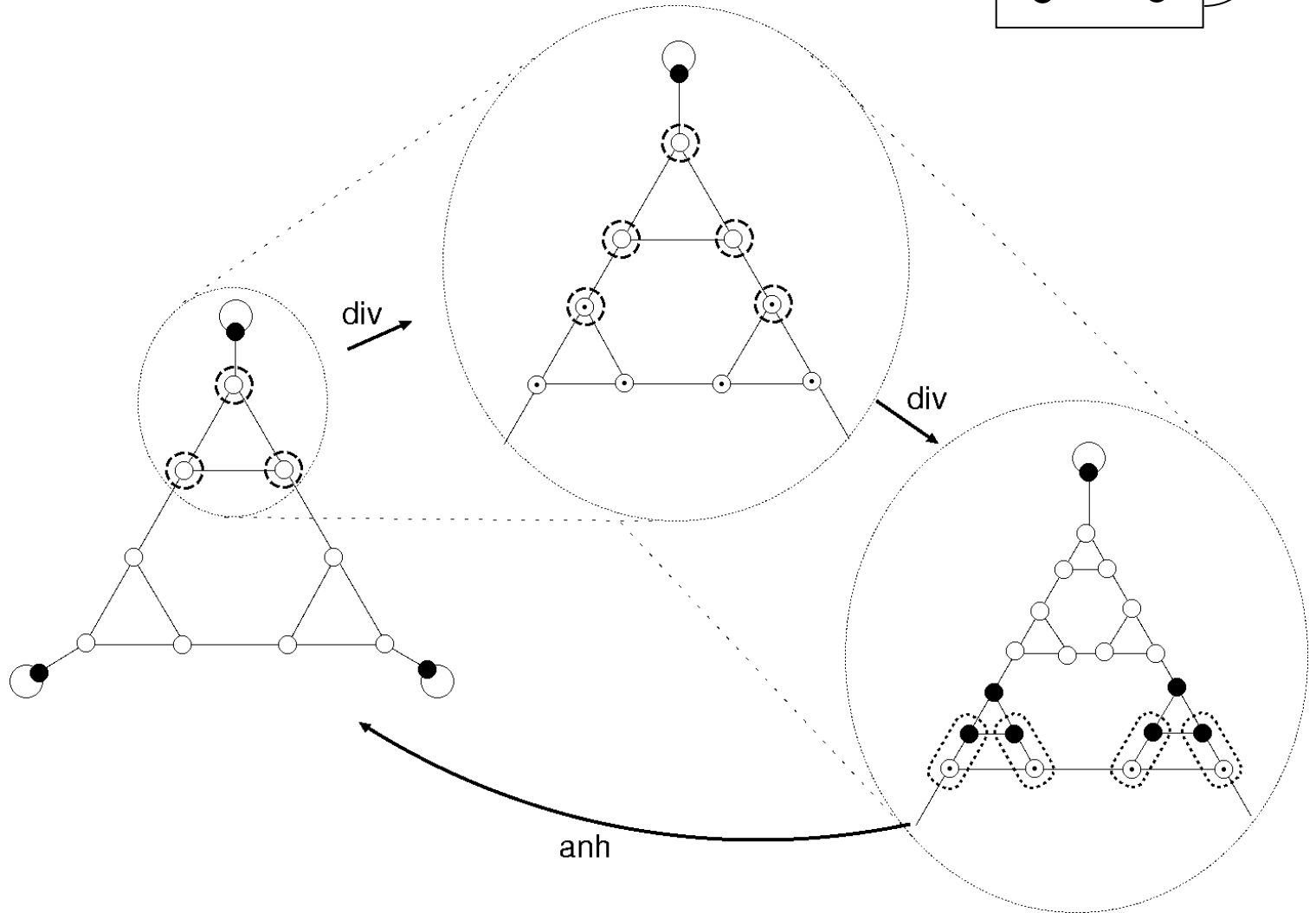
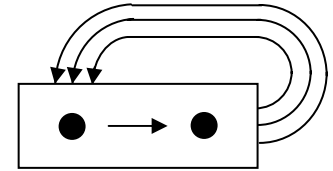

(3 states, 5 rules)

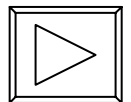

Pattern 3:

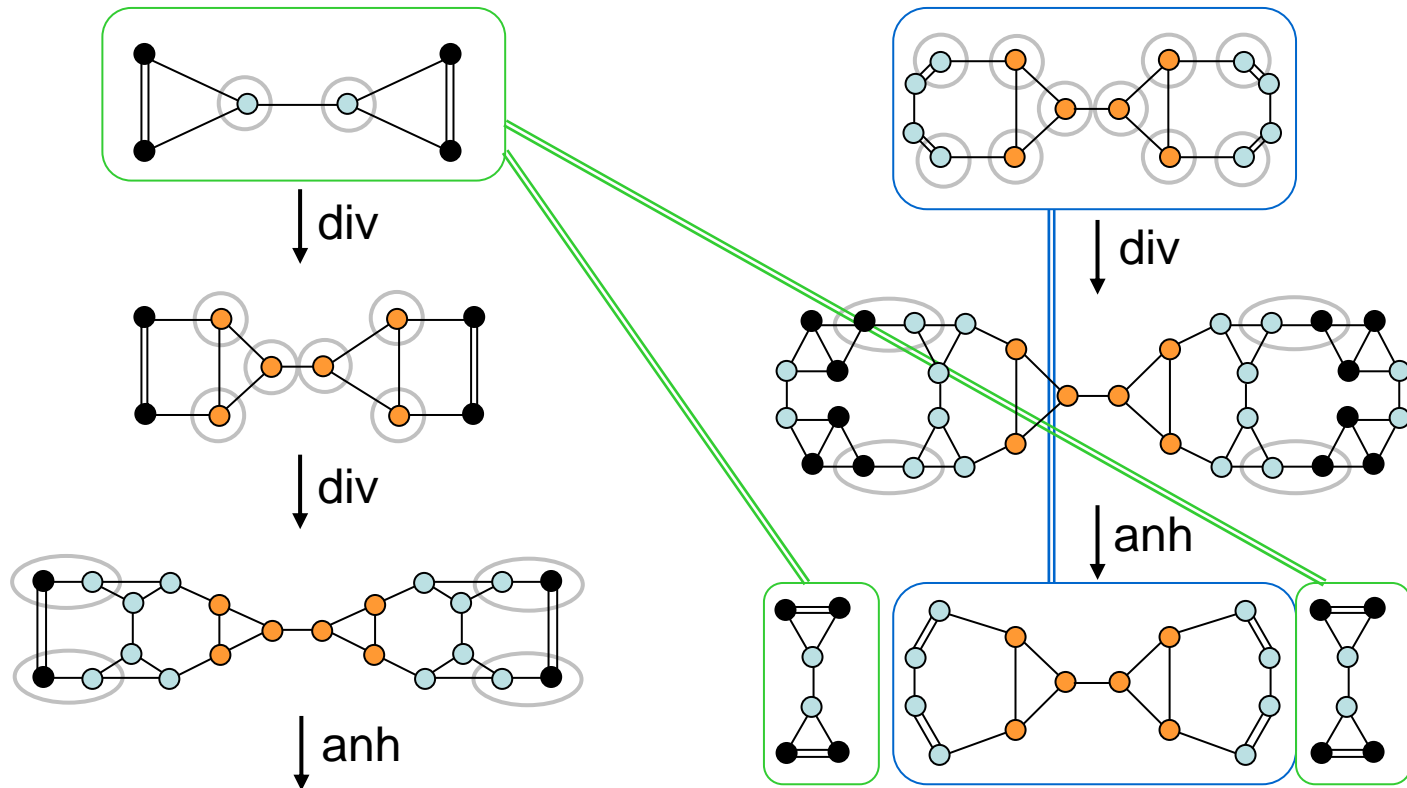
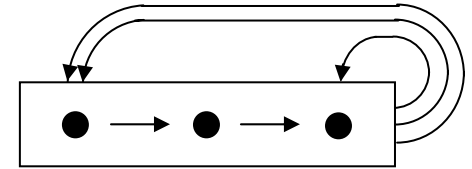

(3 states, 6 rules)

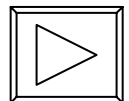

Self-replication with two states

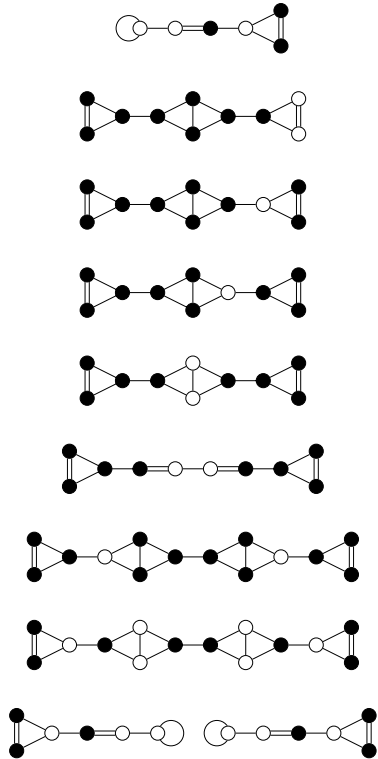

01100202 201 2

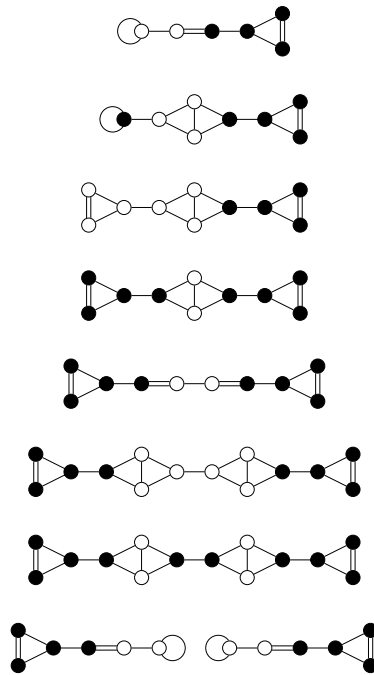
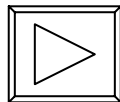

03002310 201 1

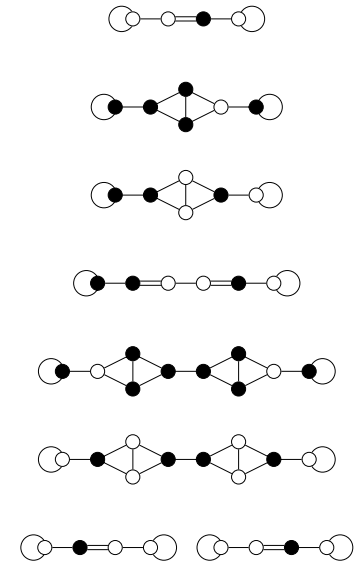
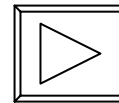

01110200 201 2

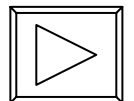

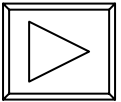
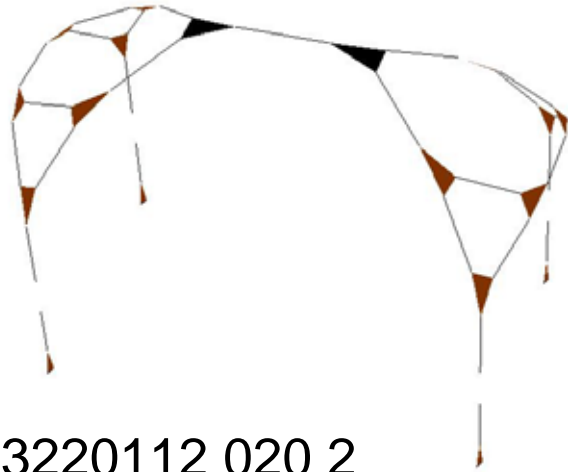

03220112 020 2

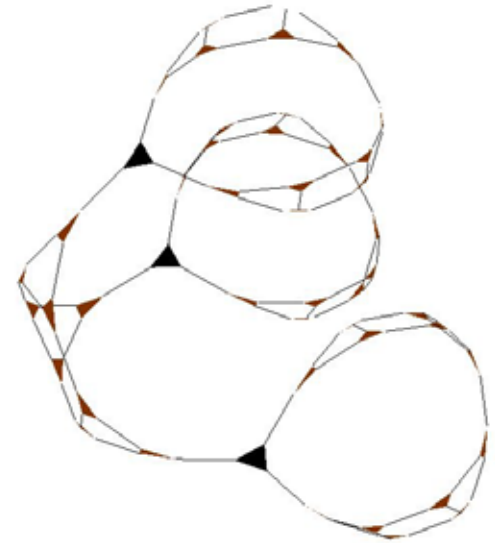

03120021 201 1

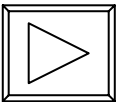
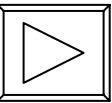

03010212 202 1